

oggetto:	Scheda Tecnica
identificazione:	SC-MI3213PB08
Pag. 1 di 5	Rev. 1

Curve di Pressione e Forza / Pressure and Force Diagram

0	Emissione	NICOLETTI A.	MARCHINI A.	09.12.2024
Rev.	Motivo:	Redatto da RAQ:	Approvato da:	Data:

Curve di Pressione e Forza / Pressure and Force Diagram

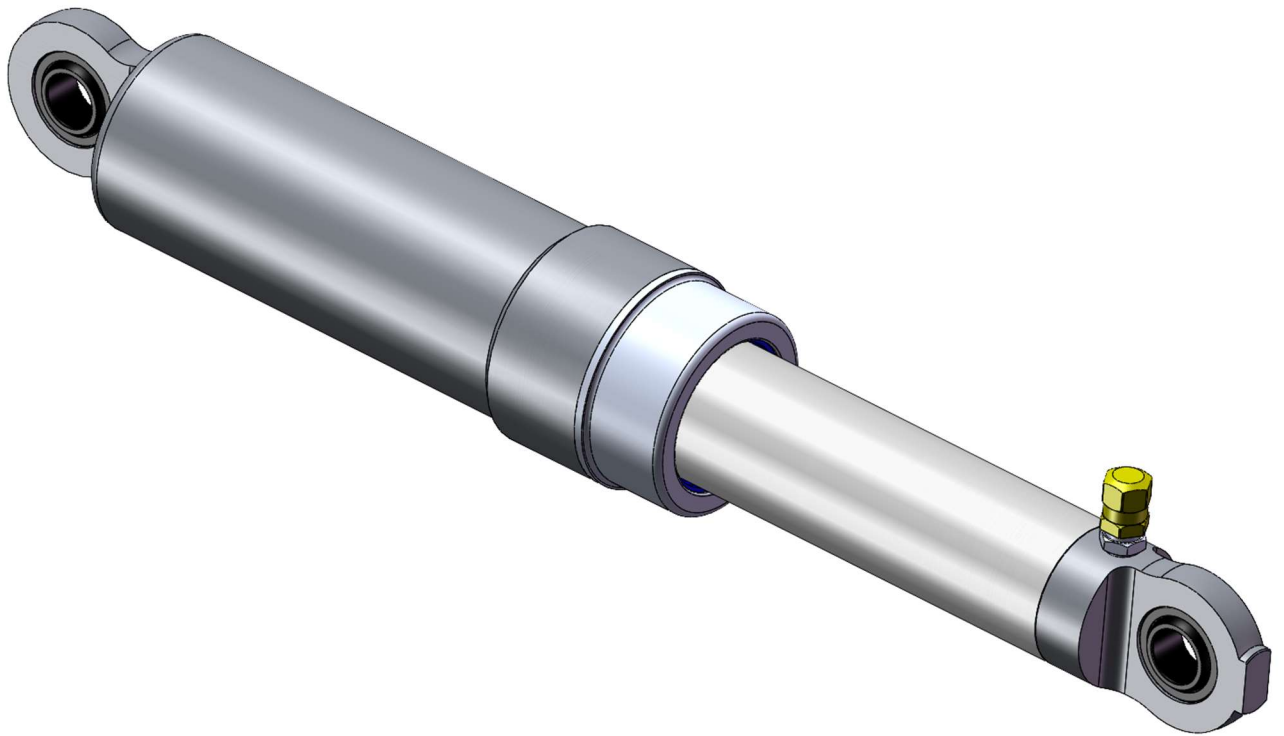
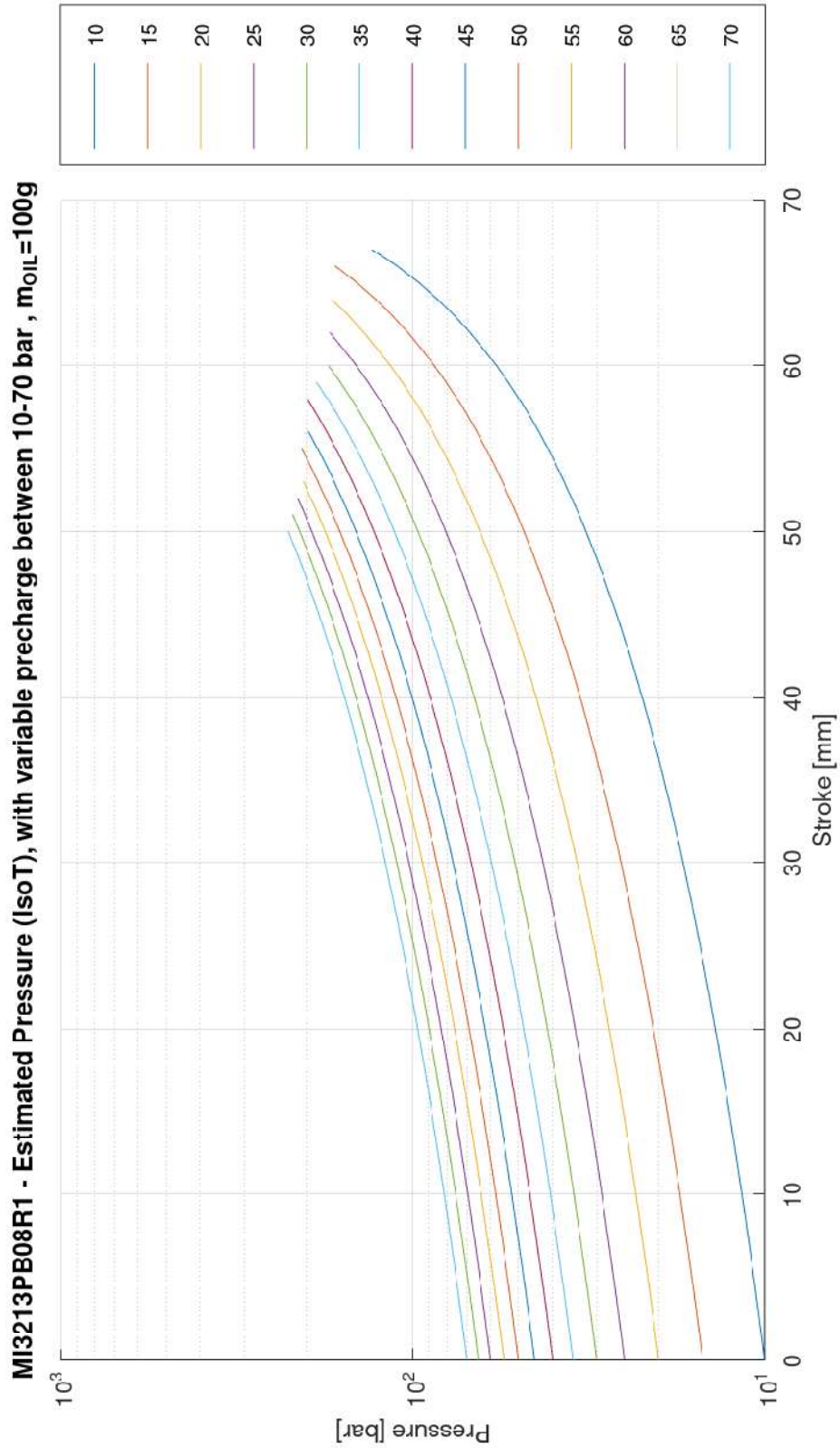

Curve di Pressione e Forza / Pressure and Force Diagram

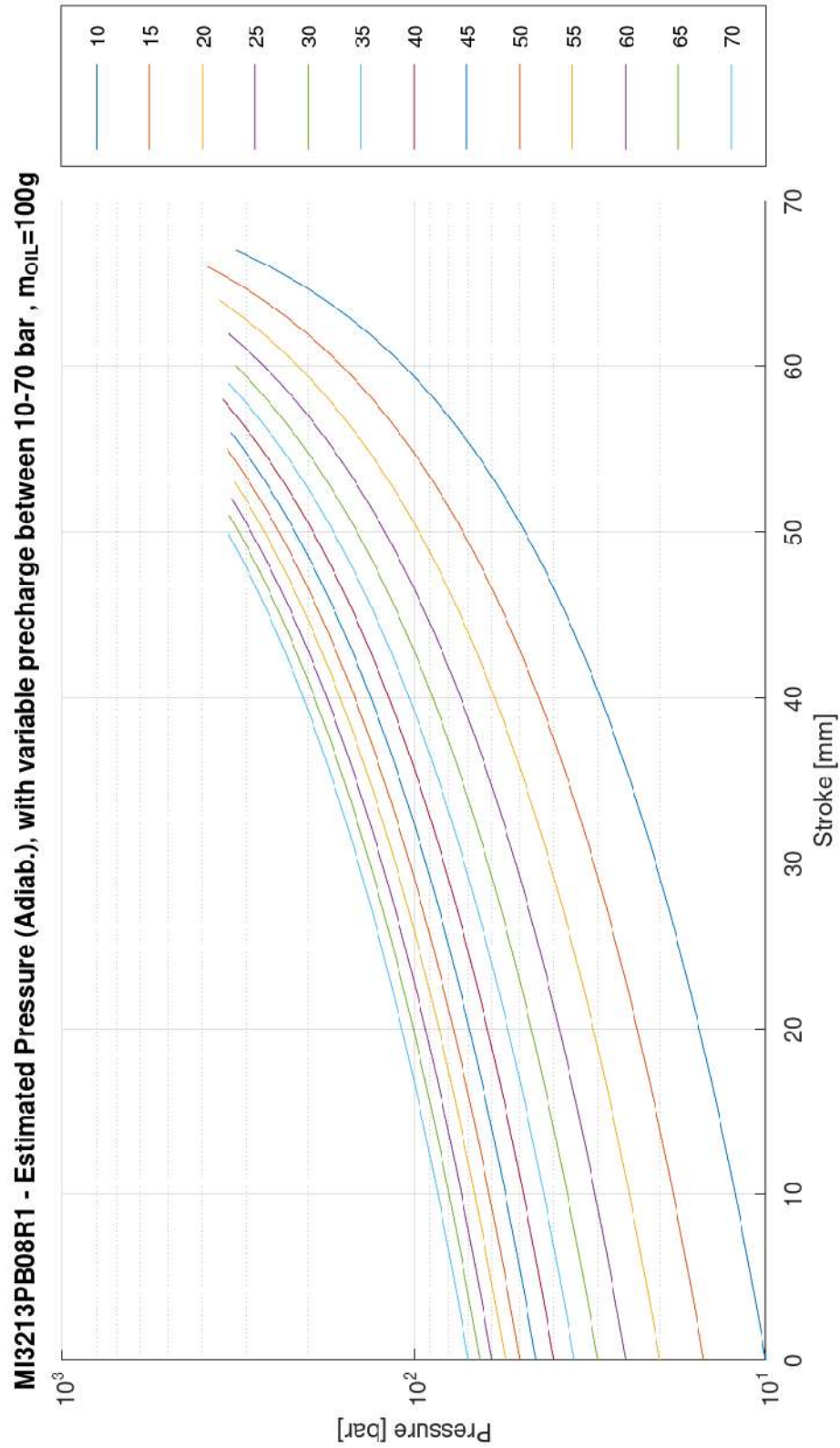

Curve di Pressione e Forza / Pressure and Force Diagram

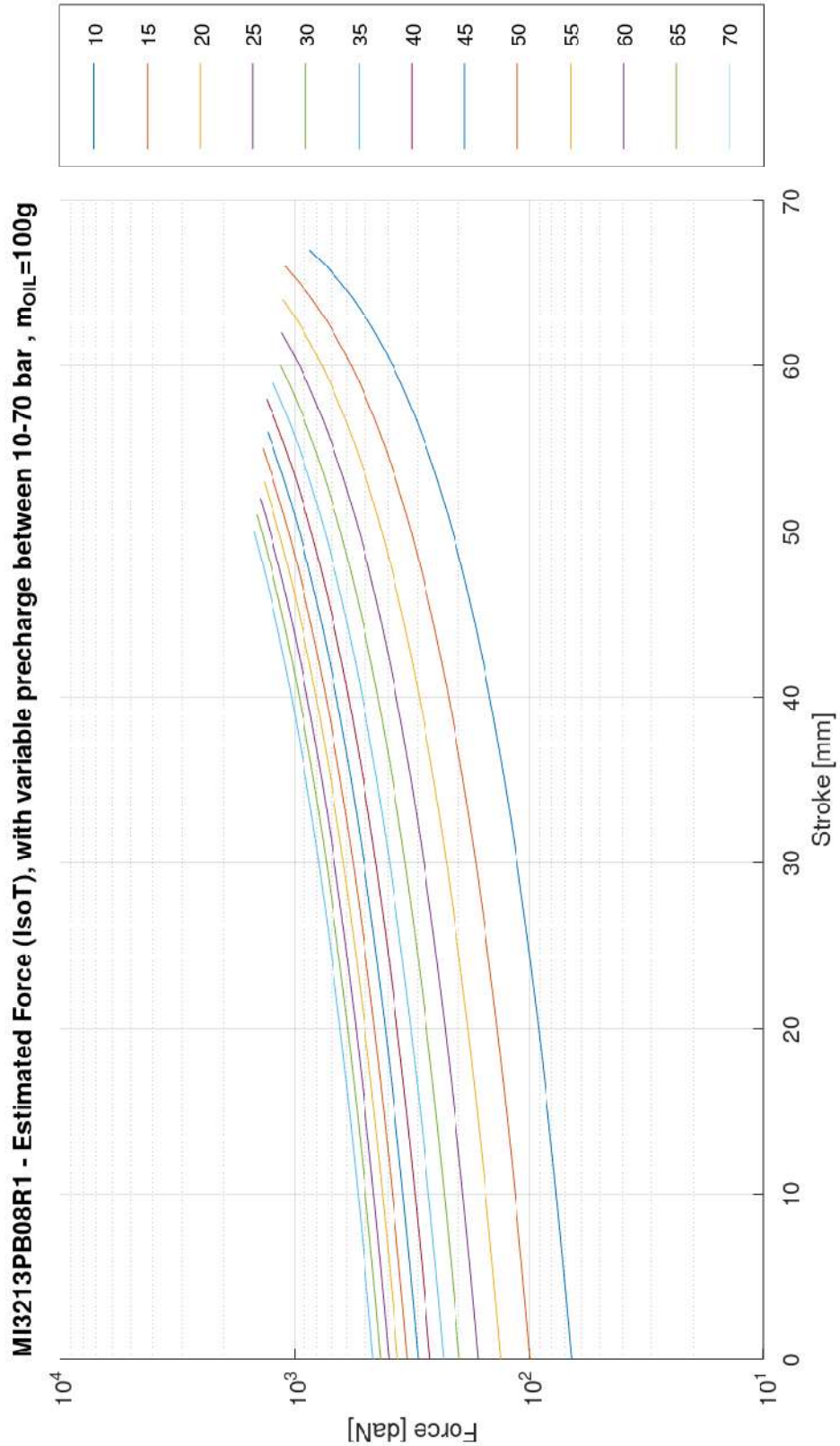

Curve di Pressione e Forza / Pressure and Force Diagram

